

## IBISCO

gałka drzwiowa

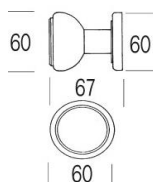

cena za szt.

wykończenie		BDR
chrom	<b>CR</b>	369.04
chrom/chrom-satyna	<b>CR/CRS</b>	377.88
nikiel-satyna	<b>NS</b>	330.86

## IBISCO

gałka drzwiowa

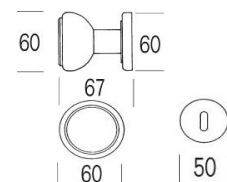

cena z kpl.

wykończenie		WK
chrom	<b>CR</b>	812.83
chrom-satyna	<b>CRS</b>	826.53
nikiel-satyna	<b>NS</b>	744.29

## MIRTO

gałka drzwiowa

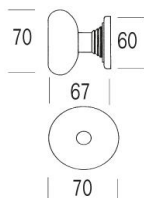

cena za szt.

wykończenie		BDR
chrom	<b>CR</b>	528.08
chrom-satyna	<b>CRS</b>	528.08
nikiel-satyna	<b>NS</b>	528.08

## MIRTO

gałka drzwiowa

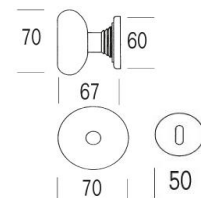

cena z kpl.

wykończenie		WK
chrom	<b>CR</b>	1142.23
chrom-satyna	<b>CRS</b>	1142.23
nikiel-satyna	<b>NS</b>	1142.23

## PAPILLON

gałka drzwiowa

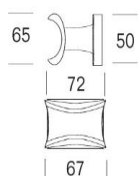

cena za szt.

wykończenie		BDR
		<b>6099</b>
chrom	<b>CR</b>	368.55
chrom-satyna	<b>CRS</b>	357.14
chrom-satyna/chrom	<b>CRS/CR</b>	363.30
nikiel-satyna	<b>NS</b>	343.10

## PAPILLON

gałka drzwiowa

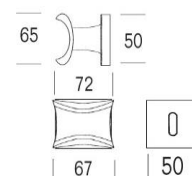

cena z kpl.

wykończenie		WK
		<b>6099</b>
chrom	<b>CR</b>	909.65
chrom-satyna	<b>CRS</b>	844.31
chrom-satyna/chrom	<b>CRS/CR</b>	856.70
nikiel-satyna	<b>NS</b>	825.61

## TIMO

gałka drzwiowa

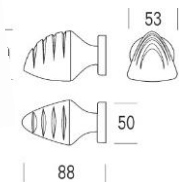

cena za szt.

wykończenie		BDR
		<b>6055</b>
chrom	<b>CR</b>	312.01
chrom-satyna/chrom	<b>CRS/CR</b>	326.92
nikiel-satyna/nikiel	<b>NS/NL</b>	326.92

## TIMO

gałka drzwiowa

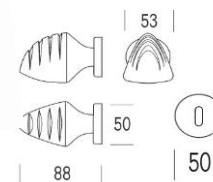

cena z kpl.

wykończenie		WK
		<b>6055</b>
chrom	<b>CR</b>	698.68
chrom-satyna/chrom	<b>CRS/CR</b>	724.76
nikiel-satyna/nikiel	<b>NS/NL</b>	736.52

## ANATOMICA

pochwyt drzwiowy

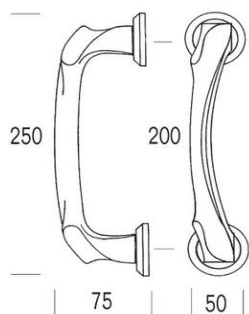

cena za szt.

wykończenie		<b>4874</b>
chrom	<b>CR</b>	723.21
chrom-satyna	<b>CRS</b>	748.23
nikiel-satyna	<b>NS</b>	748.23

## ANATOMICA SQ

pochwyt drzwiowy

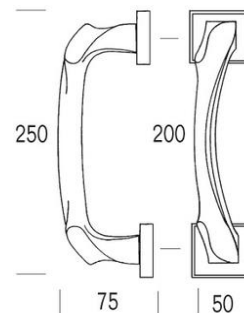

cena za szt.

wykończenie		<b>6109</b>
chrom	<b>CR</b>	794.28
chrom-satyna	<b>CRS</b>	758.67
grafit	<b>GR</b>	794.28
nikiel-satyna	<b>NS</b>	758.67

## BEGONIA

pochwyt drzwiowy

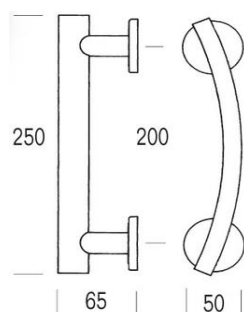

cena za szt.

wykończenie		<b>4834</b>
chrom	<b>CR</b>	498.49
chrom-satyna	<b>CRS</b>	540.03
nikiel-satyna	<b>NS</b>	540.03

## CEDRO

pochwyt drzwiowy

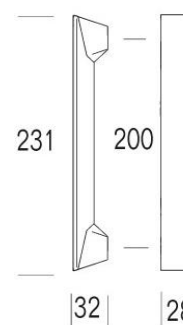

cena za szt.

wykończenie		<b>6064</b>
chrom	<b>CR</b>	450.11
chrom-satyna	<b>CRS</b>	469.15
grafit	<b>GR</b>	492.62
nikiel-satyna	<b>NS</b>	469.15

## IPOMEA

pochwyt drzwiowy

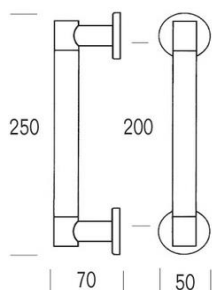

cena za szt.

wykończenie		<b>4824</b>
chrom	<b>CR</b>	511.80
chrom-satyna	<b>CRS</b>	492.62
mosiądz	<b>OL</b>	520.50

## LINK

pochwyt drzwiowy

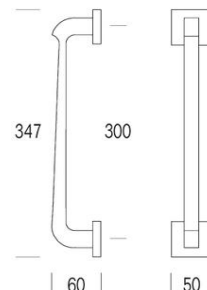

cena za szt.

wykończenie		<b>6119/A</b>
chrom	<b>CR</b>	710.43
chrom-satyna	<b>CRS</b>	663.41
mosiądz	<b>OL</b>	639.41

## MIRTO

pochwyt drzwiowy

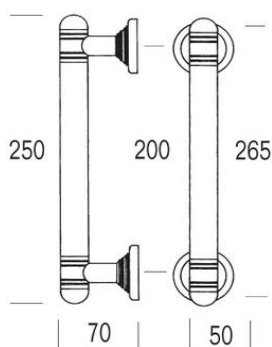

cena za szt.

wykończenie		<b>14484</b>
chrom	<b>CR</b>	504.71
chrom-satyna	<b>CRS</b>	513.65
mosiądz	<b>OL</b>	513.65

## TIMO

pochwyt drzwiowy

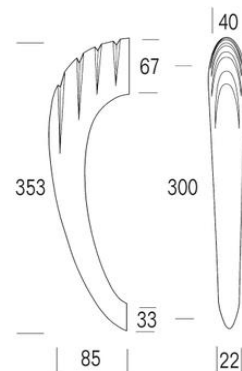

cena za szt.

wykończenie		<b>6054/A</b>
chrom	<b>CR</b>	477.02
chrom-satyna/chrom	<b>CRS/CR</b>	514.43
nikiel-satyna/nikiel	<b>NS/NL</b>	514.43

## TUBE

pochwyt drzwiowy

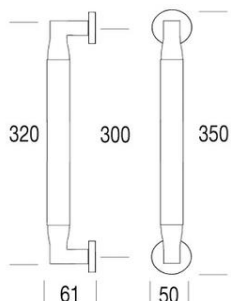

cena za szt.

wykończenie		<b>6139</b>
chrom	<b>CR</b>	525.31
chrom-satyna	<b>CRS</b>	493.78
chrom/chrom-satyna	<b>CR/CRS</b>	508.60
chrom-satyna/chrom	<b>CRS/CR</b>	516.08

## TUBE

pochwyt drzwiowy

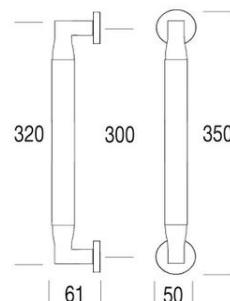

cena za szt.

wykończenie		<b>6139</b>
grafit	<b>GR</b>	573.06
grafit/łtoczona faktura	<b>GR/Z</b>	582.14
chrom/łtoczona faktura	<b>CR/Z</b>	600.65
chrom-satyna/łtoczona faktura	<b>CRS/Z</b>	582.14

## ZEN

pochwyt drzwiowy

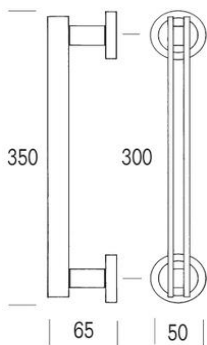

cena za szt.

wykończenie		<b>6029/A</b>
chrom	<b>CR</b>	604.20
chrom-satyna	<b>CRS</b>	601.96
nikiel-satyna	<b>NS</b>	610.37

## ZEN

pochwyt drzwiowy

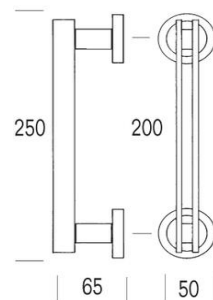

cena za szt.

wykończenie		<b>6029/B</b>
chrom	<b>CR</b>	514.43
chrom-satyna	<b>CRS</b>	514.43
nikiel-satyna	<b>NS</b>	523.07

## ZEN SQ

pochwyt drzwiowy

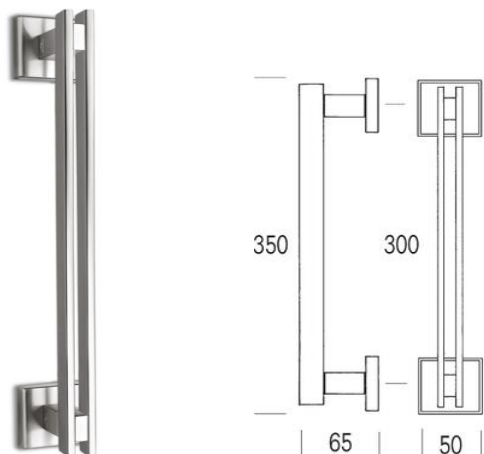

cena za szt.

wykończenie		<b>6084/A</b>
chrom	<b>CR</b>	687.07
chrom-satyna	<b>CRS</b>	639.32
grafit	<b>GR</b>	687.07
nikiel-satyna	<b>NS</b>	639.32

## ZEN SQ

pochwyt drzwiowy

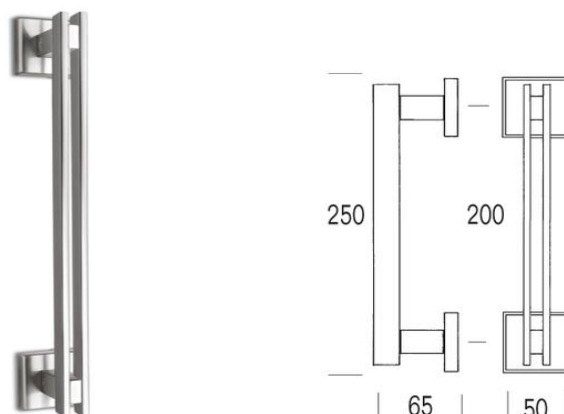

cena za szt.

wykończenie		<b>6084/B</b>
chrom	<b>CR</b>	593.80
chrom-satyna	<b>CRS</b>	551.73
grafit	<b>GR</b>	593.80
nikiel-satyna	<b>NS</b>	551.73

## ARES

klucz

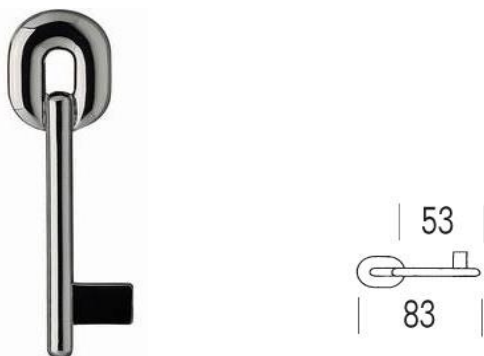

cena za szt.

wykończenie		<b>6064</b>
chrom	<b>CR</b>	37.45
chrom-satyna	<b>CRS</b>	39.40
etrusco	<b>ETR</b>	37.02
grafit	<b>GR</b>	39.40
nikiel-satyna	<b>NS</b>	39.40
mosiądz	<b>OL</b>	32.50

## ERA

klucz

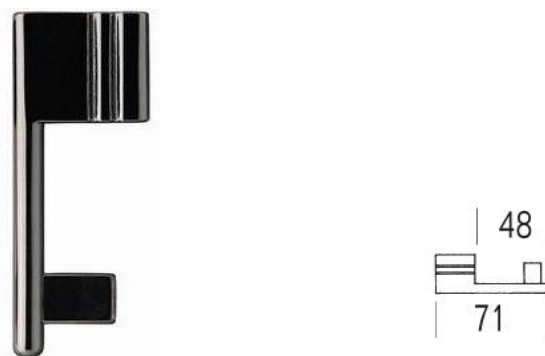

cena za szt.

wykończenie		<b>4834</b>
chrom	<b>CR</b>	48.72
chrom-satyna	<b>CRS</b>	55.09
etrusco	<b>ETR</b>	48.24
grafit	<b>GR</b>	50.52
nikiel-satyna	<b>NS</b>	50.52
mosiądz	<b>OL</b>	45.95